

# Recreation Park Bandshell, Long Beach CA

## Technical Information for Bands & Vendors

Sponsored by Friends of Rec Park Bandshell (FORPBS)

[info@forpbs.org](mailto:info@forpbs.org)

[www.forpbs.org](http://www.forpbs.org)

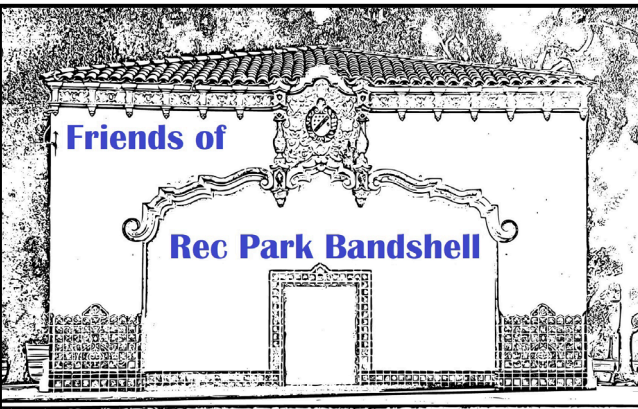



# About the Bandshell

- *The Shell* is East Long Beach's Premier Outdoor Amphitheater.
- *The Shell* has many unique features that make it a great venue for outdoor music and theatre including:
  - Large 30x60 ft raised stage plus backstage and wing stage areas.
  - Seating for over 600 plus additional grass areas for open picnic space.
  - Directly next to the new children's playground and public restrooms.
  - Located in Recreation Park, a large recreational area with good parking, across from Wilson HS, next to Blair Field.
  - Near Long Beach residential areas, but far enough away to mitigate noise.

The Spanish Baroque Revival Bandshell was built in 1929 and is a Registered Historic Landmark



Stage Side Building



Street Side Building Entrance



# About FORPBS

- *FORPBS* (Friends of Rec Park Bandshell) is a 501.c.3 non-profit fiscally sponsored by Partners of Parks.
- FORPBS volunteers are local musicians, sound engineers and arts patrons that want to help bring back live music to *The Shell*.
- At FORPBS we have the following goals
  - Bring back the regular use of the Historic Landmark Bandshell.
  - Focus on local Long Beach talent including our community's youth.
  - Raise funds over time through government, business and private donations for full renovation of the Bandshell.
  - Create a lasting foundation that will promote the use and maintenance of the Bandshell for years to come.

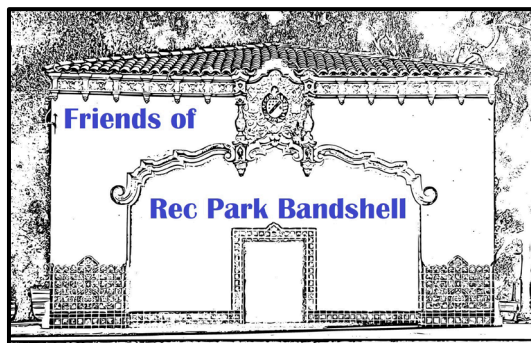

# What FORPBS Can Provide

- FORPBS can provide the following services:
  - Acquire all city Parks and Rec permits for facility use, including required Parks and Rec staff.
  - Provide full sound and stage production including main sound system, all microphones, cabling, lighting, professional mix engineers, etc. Ability to handle small instrumentals to full rock bands to big band orchestras.
  - Help with pre-event marketing through our business sponsorships, social media and email lists.
  - Help with day of logistics of load in and out, pop-up booth space for promotional materials, etc.
- FORPBS is a 501.c.3 non-profit. All fees we collect for the above services are considered a donation to FORPBS.

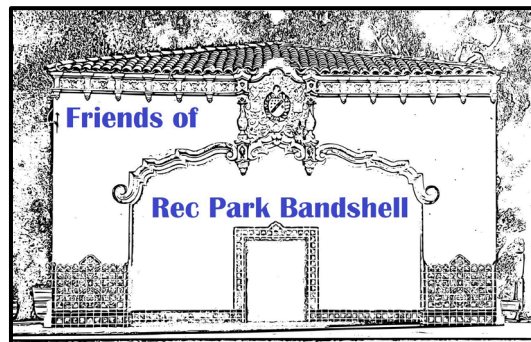

# Location and Layout

Location: 701-939 Federation Dr, Long Beach, CA 90814 at the corner of E 7<sup>th</sup> St and Park Ave



# Location and Layout

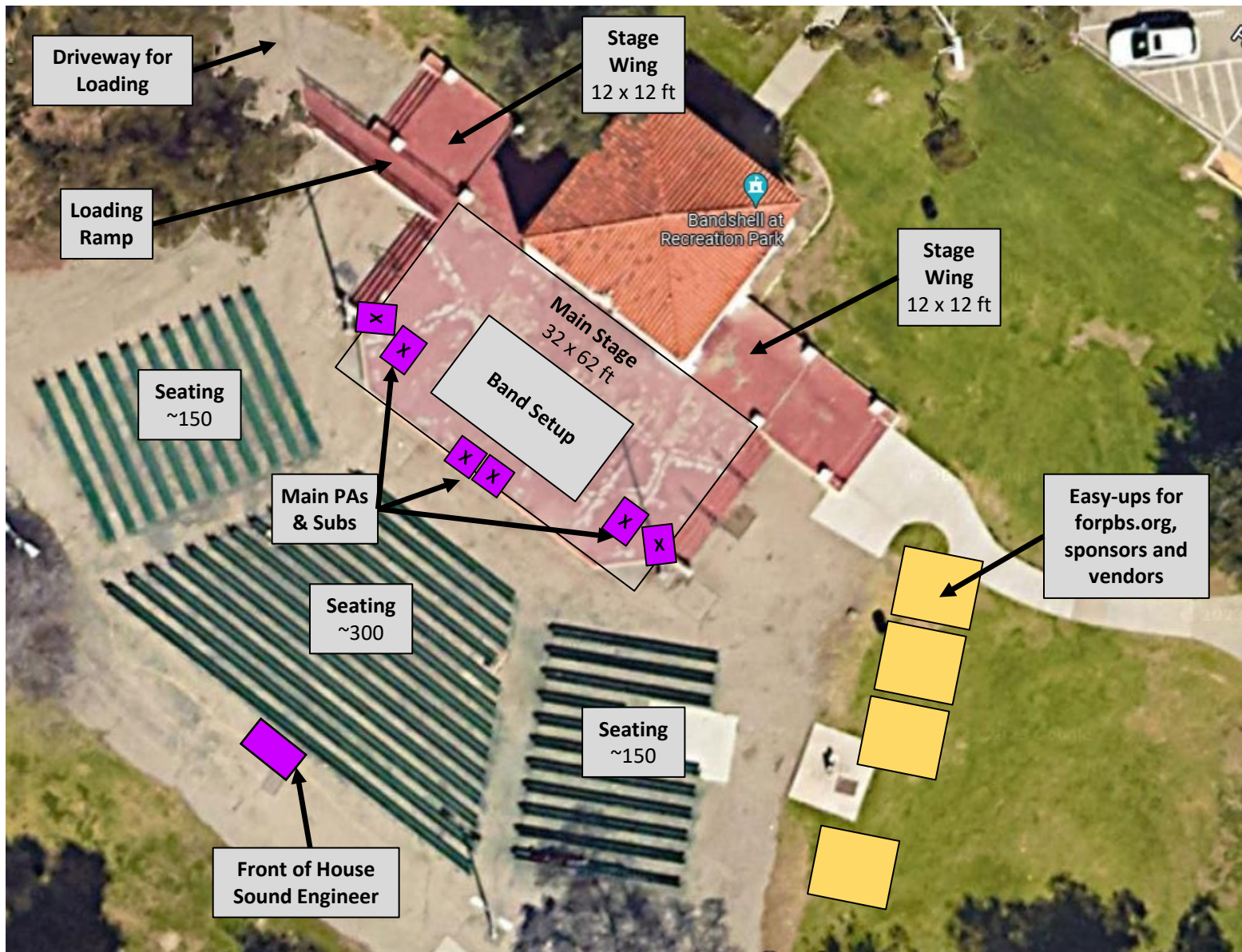



# Actual Stage Dimensions

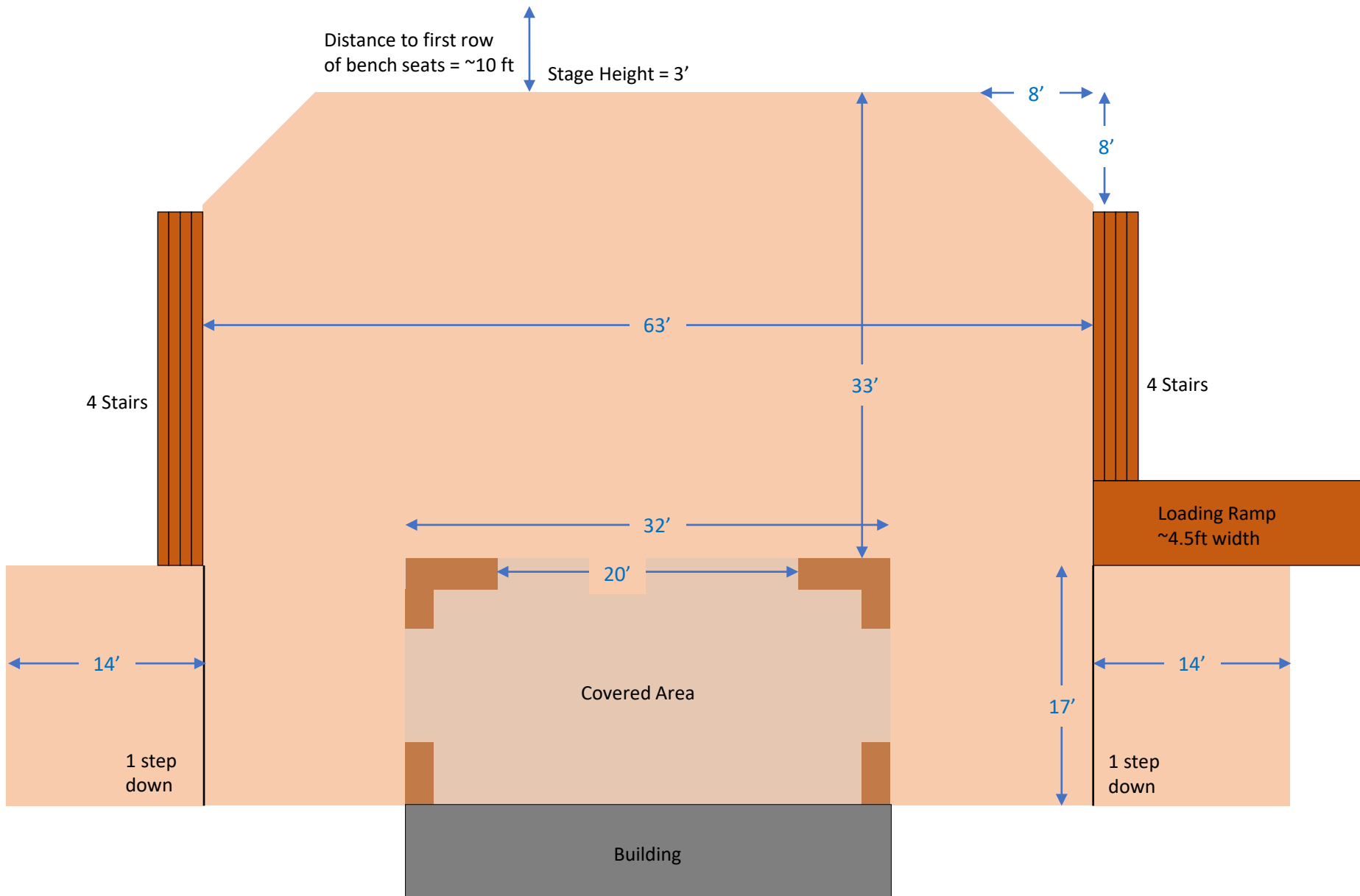

# Typical Stage Setup

## Example Setup Rec Park Bandshell

### Channels

1. VOX 1 (W1)
2. VOX 2 (W2)
3. VOX 3 (W3)
4. VOX 4 (W4)
5. VOX 5 (W5)
8. VOX MC (W8)
- 9: Lead GTR (W6)
10. Bass GTR - DI
11. Sax (Band wireless)
12. Trumpet (Band wireless)
- 13-14. Keys - DI
- 15-16. House
- 17-19. Drums

### Output Channels

- 1-6. Monitor Wedges
- 15-16. Mains

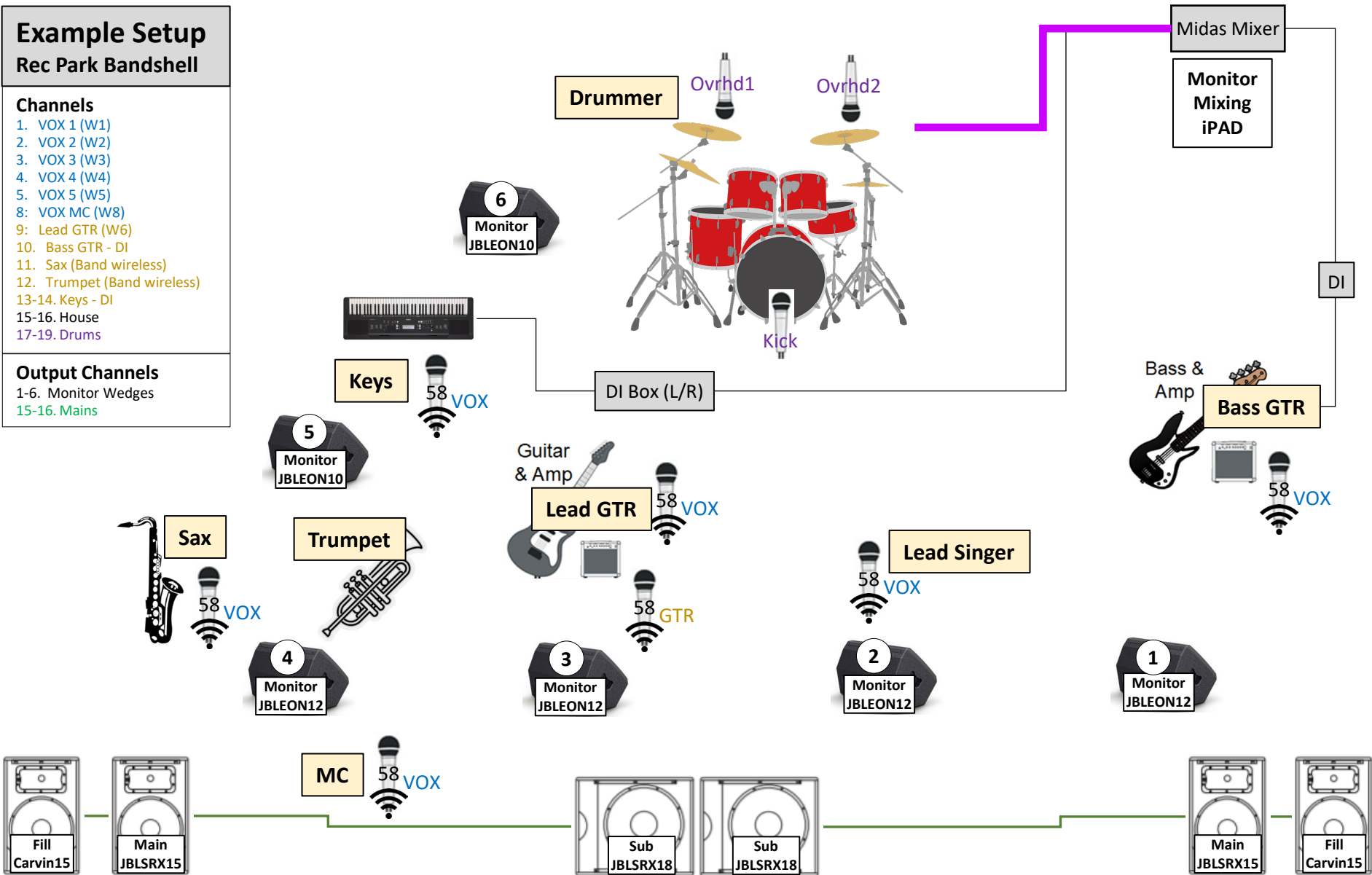



# Typical Sound Engineer Setup

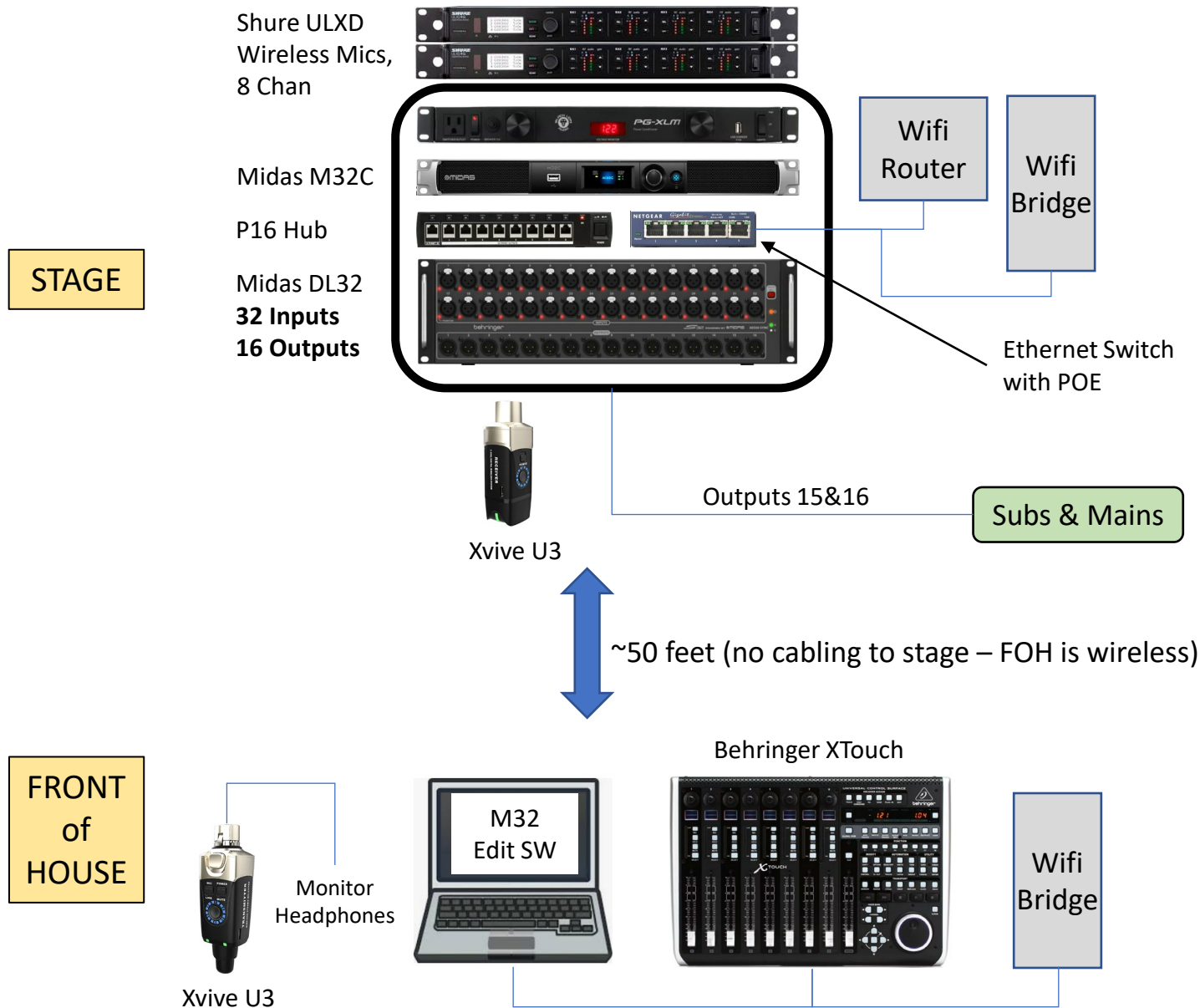



# FORPBS House Equipment List



- PA
  - JBL SRX 15" tops & 18" subwoofers.
  - Fill: Carvin 15"
- Mixer
  - Midas M32 mixer & 32 Chan stage box (digital snake) with Wifi control.
  - FOH Behringer X-Touch mixer board.
- Monitors/Fill Speakers & Systems
  - 4x EON712, 12", 2x JBL EON610, 10", 2x Carvin 10" wedge monitors.
  - 6x Behringer P16-M personal monitors via Ultranet. Allows each musician to adjust their own monitor mix. Analog output to wedge, Xvive or IEM.
  - 6x Xvive U4 wireless systems (plug in your own 1/8" earbuds).
- Vocal Mics
  - Wireless: Shure ULXD, 8 channel with SM58 handhelds, lavalier mics, bodypacks, etc.
  - Wired: 5x Shure SM58, 1x Shure Beta 58A, 2x Behringer XM8500, 2x Shure SM35 "Britney", Audio-Technica AT2035 (for MC/announcer or crowd mic).
- Instrument Mics
  - 3x guitar amp mics, GLS ES-57.
  - 1x bass amp mic, AKG P2.
  - Audix DP7, 7-piece drum mic set.
    - 1x D6 for kick drum.
    - 1x i5 for snare (clip on mic).
    - 2x D2s for toms (clip on mic).
    - 1x D4 for floor tom (clip on mic).
    - 2x ADX51s for overheads.
  - DI Boxes for Keys and/or guitar amps as needed.
- Backline & Misc
  - Fender Rumble 200 bass amp.
  - Mic stands, ~20+.
  - All cables.
- Not provided
  - Guitar and bass amps.
  - Bring vocal mics if desired.
  - IEMs.



# Band Questionnaire



- Band & band leader name \_\_\_\_\_
- Email & cell \_\_\_\_\_
- Band website, facebook, Instagram, etc. \_\_\_\_\_
- Music genre (classic rock, etc.) \_\_\_\_\_
- Band Members

No	Band Member Name	Description Lead/Rhy G, Bass, Keys, Drums, etc.	Direct Out or Mic on GTR Amp?	Vocal Mic?	IEM or Wedge
1					
2					
3					
4					
5					
6					
7					
8					

- Drums – description of kit: \_\_\_\_\_ Preferred drum mics: \_\_\_\_\_
- Any additional Band info you can provide

---



---



---



---